

Description

One, two and three pole thermal-magnetic circuit breakers with trip-free mechanism and toggle actuation (S-type TM CBE to EN 60934/IEC 934). Featuring a combi-foot design for both symmetric and asymmetric rail mounting. Available with auxiliary contact (1 x N/O or 1 x N/C) for status signalling. Two and three pole models are internally linked to ensure that both/all poles trip in the event of an overload on one pole, even if the actuator is held in the ON position. This CBE can be supplied in current ratings up to 32 A with a choice of characteristic curves. All screw terminals are recessed for safety. Approved to CBE standard EN 60934 (IEC 60934).

Typical applications

Process control equipment, robotics, machine tool control, communications systems, instrumentation.

Ordering information

Type No.	2210	single and multipole thermal-magnetic circuit breaker
Mounting	T	rail mounting
Actuator design	2	toggle
Number of poles	1, 2, 3	1 single pole protected 2 2-pole protected 3 3-pole protected
Accessories	0	without accessories
Terminal design (main contacts)	K0	screw terminals
Characteristic curve	F1, F2, M1, T1	F1 fast acting: therm. 1.01-1.4xI _N ; magn. 2-4xI _N DC (DC only) F2 fast acting: therm. 1.01-1.4xI _N ; magn. 3.5-6.5xI _N AC/4.5-8.5xI _N DC M1 standard delay: therm. 1.01-1.4xI _N ; magn. 6-12xI _N AC, 7.8-15.6xI _N DC T1 delayed: therm. 1.01-1.4xI _N ; magn. 10-20xI _N AC
Auxiliary contact design	H	without intermediate position
Auxiliary contacts	1, 2	1 with auxiliary contacts 2 auxiliary contacts on pole 1 only (multipole devices)
Auxiliary contact function (see diagrams)	2, 3	2 1 N/O contact 3 1 N/C contact
Auxiliary contact - terminal design	1	screw terminals
Current ratings	0.1...32 A	
2210 - T 2 1 0 - K0 M1- H 1 2 1 - 10 A ordering example		

Preferred types

Preferred types	Standard current ratings (A)										
	0.5	1	2	3	4	5	6	8	10	16	20
1-pole											
2210-T210-K0M1-H121-	x	x	x	x	x	x	x	x	x	x	x
2-pole											
2210-T220-K0M1-H221-			x	x			x		x	x	x

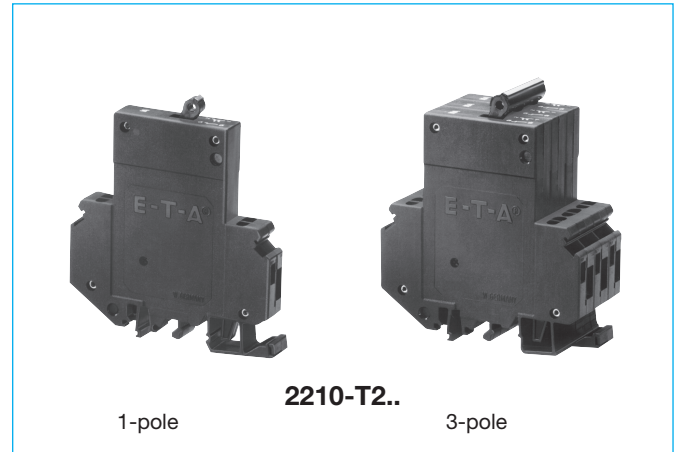

Technical data

For further details please see chapter: Technical Information

Voltage rating	AC 250 V; 3 AC 433 V (50/60 Hz); DC 65 V (UL: AC 277/480 V; DC 65 V)	
Current rating range	0.1...32 A for curves M1, T1 0.1...16 A for curves F1, F2	
Auxiliary circuit	1 A, AC 240 V/DC 65 V, resistive	
Typical life	3 AC 433 V; AC 250 V: 0.1...25 A 10,000 operations at 1 x I _N , inductive DC 65 V: 0.1...32 A 10,000 operations at 1 x I _N , inductive 3 AC 433 V; AC 250 V: 32 A 10,000 operations at 1 x I _N , resistive	
Ambient temperature	-30...+60 °C (-22...+140 °F) T 60	
Insulation co-ordination (IEC 60664 and 60664 A)	rated impulse withstand voltage 2.5 kV	pollution degree 2 reinforced insulation in operating area
Dielectric strength (IEC 60664 and 60664A)	test voltage operating area main/aux. circuit pole/pole	AC 3,000 V AC 3,000 V AC 1,500 V
Insulation resistance	> 100 MΩ (DC 500 V)	
Interrupting capacity I _{cn}	0.1...5 A 6...32 A	400 A 800 A
Interrupting capacity (UL 1077)	curves F1, F2, M1, T1:	0.1...16 A, 2,500 A (at DC 32 V)
I_N	0.1...16 A	20...25 A
AC 277 V 1-pole	5,000 A	2,000 A
AC 277/480 V 2-/3-pole	5,000 A	2,000 A
DC 65 V	2,000 A	2,000 A
Degree of protection (IEC 60529/DIN 40050)	operating area IP30 terminal area IP20	
Vibration	curves F1, F2: 3 g (57-500 Hz), ± 0.23 mm (10-57 Hz) curves M1, T1: 5 g (57-500 Hz), ± 0.38 mm (10-57 Hz)	to IEC 60068-2-6, test Fc 10 frequency cycles/axis
Shock	curves F1, F2: 25 g (11 ms), directions 1, 2, 3, 4, 5 10 g (11 ms), direction 6 curves M1, T1: 25 g (11 ms), directions 1, 2, 3, 4, 5 20 g (11 ms), direction 6	to IEC 60068-2-27, test Ea
Corrosion	96 hours at 5 % salt mist to IEC 60068-2-11, test Ka	
Humidity	240 hours at 95 % RH to IEC 60068-2-78, test Cab	
Mass	approx. 60 g per pole	

Internal connection diagrams

...-H131-...

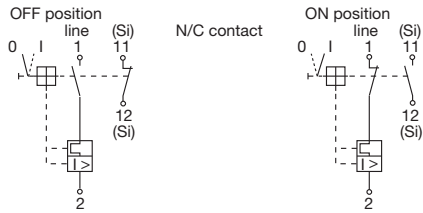

...-H121-...

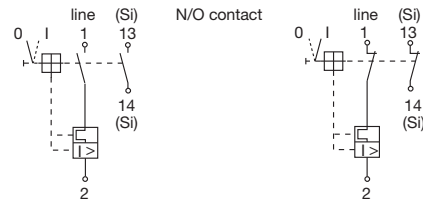

Shock directions

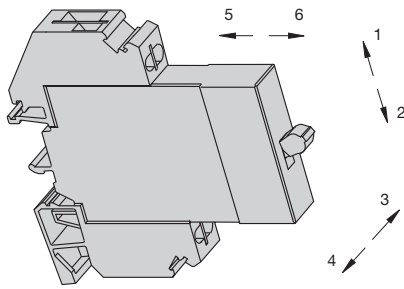

Typical time/current characteristics

-F1 0.1...16 A

DC only

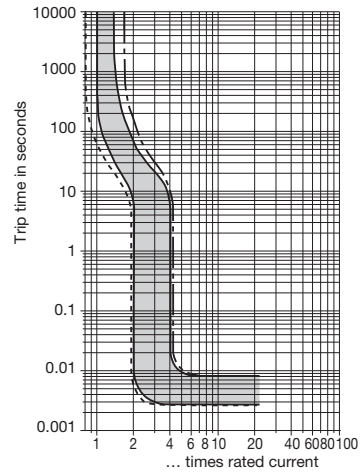

-F2 0.1...7.5 A

AC/ DC ¹⁾

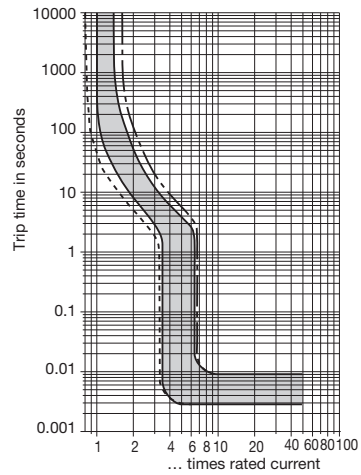

-F2 8...16 A

AC/ DC ¹⁾

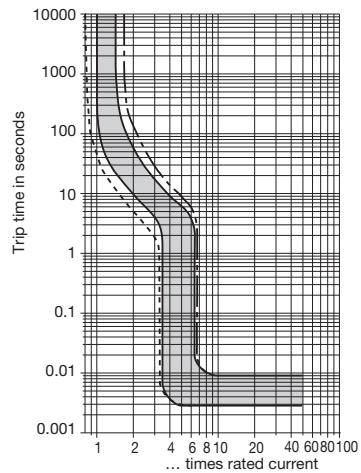

--- +60 °C / +140 °F ——— +23 °C / +73.4 °F - - - -30 °C / -22 °F

¹⁾ Magnetic tripping currents are increased by 30 % on DC supplies.

Typical time/current characteristics

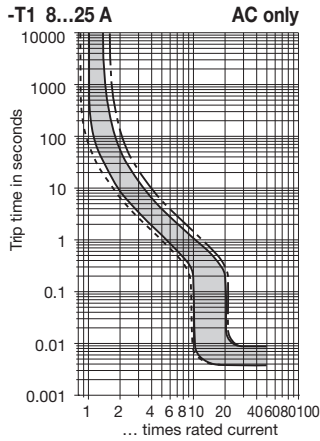
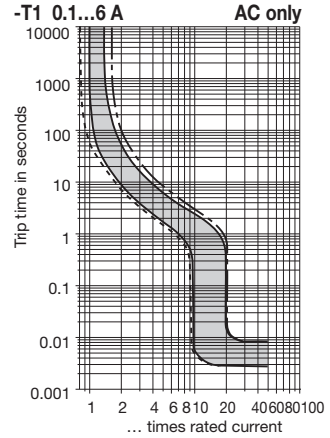
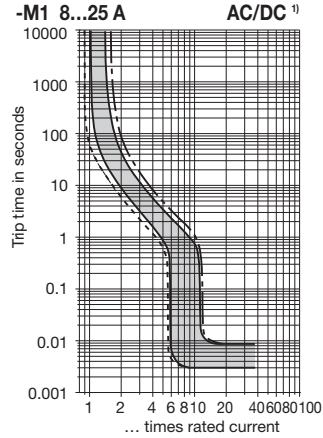
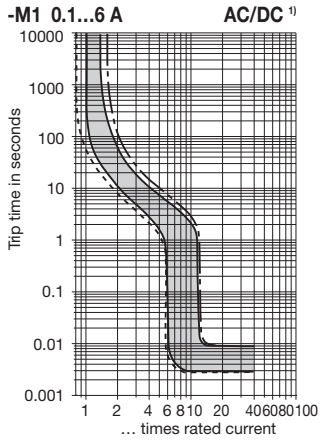

The time/current characteristic curve depends on the ambient temperature prevailing. In order to eliminate nuisance tripping, please multiply the circuit breaker current ratings by the derating factor shown below. See also section Technical information.

Ambient °F	-22	-4	+14	+32	+73.4	+86	+104	+122	+140
temp. °C	-30	-20	-10	0	+23	+30	+40	+50	+60
Derating factor	0.76	0.79	0.83	0.88	1	1.04	1.11	1.19	1.29

Multi pole devices: all poles symmetrically loaded. With single pole overload, thermal tripping will be at max. $1.7 \times I_N$ with curves F1, F2 and M1.

¹⁾ Magnetic tripping currents are increased by 30 % on DC supplies (curves M1, T1).

3

Accessories

Connector bus links -K10

X210 589 01/ 2.5 mm², (AWG 14) (black) up to 20 A max. load
X210 589 02/ 1.5 mm², (AWG 16) (brown) up to 13 A max. load

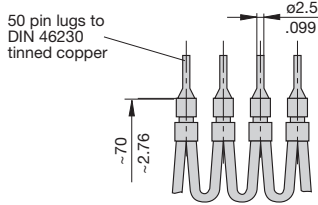

Busbar 1-pole, 90°

X 222 540 01

The one metre long busbars can be cut to suitable lengths. Plug-on caps can be fitted on the ends to provide brush contact protection.

I_{max} - busbar 100 A (40 °C)

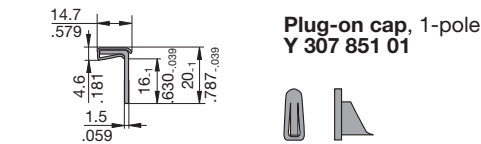
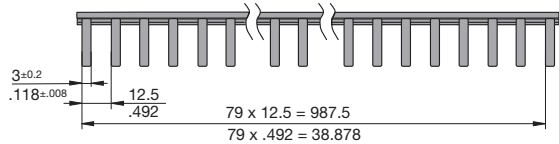

Busbar 1-pole Y 308 498 01

I_{max} - busbar 100 A (40 °C)

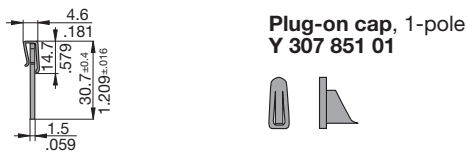
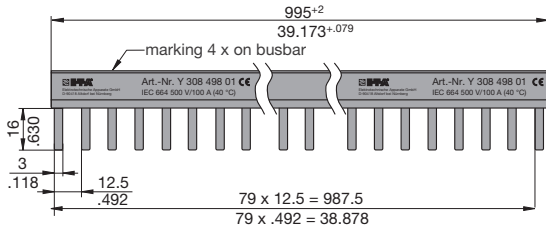

Busbar 2-pole Y 308 499 01

I_{max} - busbar 100 A (40 °C)

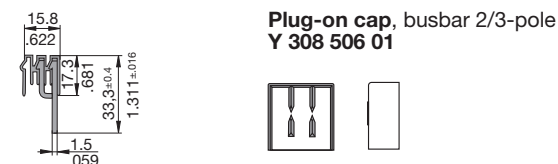
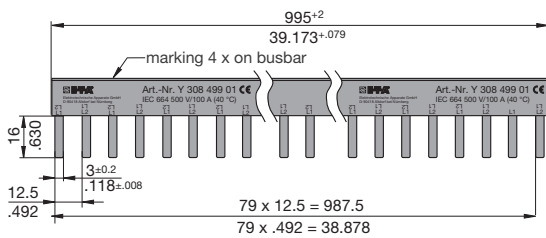

Busbar 3-pole Y 308 500 01

I_{max} - busbar 100 A (40 °C)

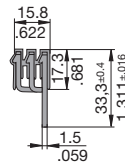
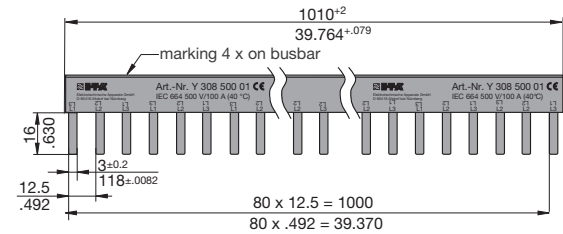

Plug-on cap, busbar 2/3-pole Y 308 506 01

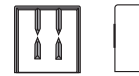

Supply terminal Y 308 503 01

I_{max} 63 A with 1-pole busbar,

50 A with multipole busbar

Max. tightening torque of terminal screw 2 Nm
 Max. cable cross section: 25 mm² / single strand
 16 mm² / multistrand
 with wire end ferrule

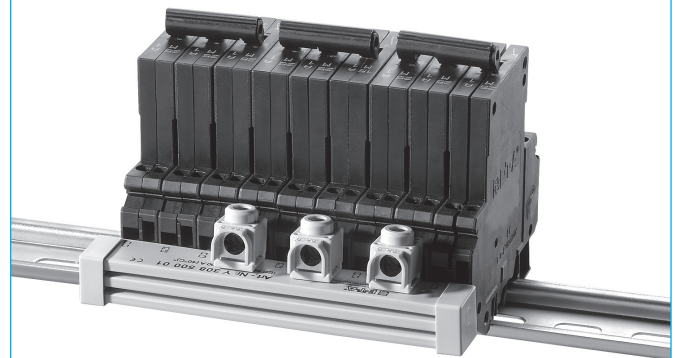
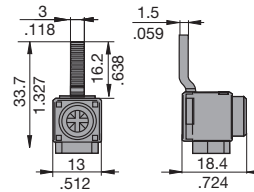

Caution:

When using multipole busbars please leave at least one pole's width between two adjacent line entry terminals.

This is a metric design and millimeter dimensions take precedence ($\frac{\text{mm}}{\text{inch}}$)

All dimensions without tolerances are for reference only. In the interest of improved design, performance and cost effectiveness the right to make changes in these specifications without notice is reserved. Product markings may not be exactly as the ordering codes. Errors and omissions excepted.

