

Description

Single and double pole hydraulic-magnetic circuit breakers with trip-free-mechanism and toggle actuation. A choice of switching characteristics ensures suitability for a wide range of applications. Industry standard dimensions and panel mounting. Auxiliary contacts optional. Low temperature sensitivity at rated load. Complies with CBE standard EN 60934 (IEC 60934) S-type HM CBE.

Typical applications

Railway vehicles.
In the business fields Communication and Transport: power supplies, switchgear, instrumentation and process control engineering.

Standard current ratings and typical internal resistance values

Current rating (A)	Trip curves and internal resistance (Ω) per pole	
	K1, M1, T1	F1, F7
0.05	531	275
0.1	58	5
1	1.10	0.578
2	0.295	0.144
3	0.121	0.064
5	0.044	0.025
10	< 0.02	< 0.01
15	< 0.01	< 0.01
20	< 0.01	< 0.01
25	< 0.01	< 0.01
30	< 0.01	< 0.01
40	< 0.01	< 0.01
50	< 0.01	< 0.01
60	< 0.01	-
80	< 0.01	-
100	< 0.01	-
125	< 0.01	-

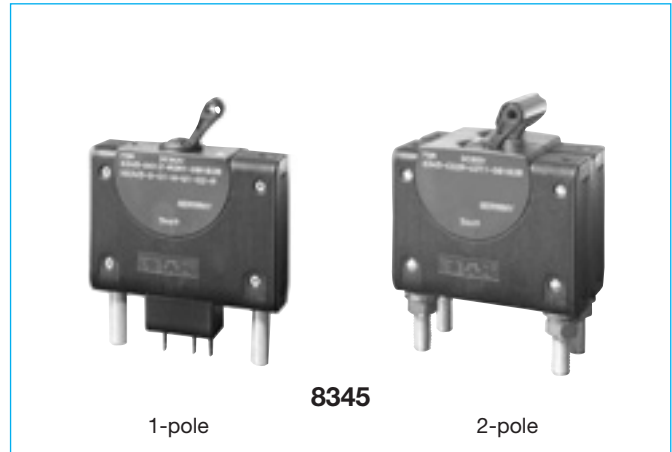

Technical data

Voltage rating	DC 110V \pm 25 %
Current rating range	0.05...125 A higher ratings upon request
Auxiliary circuit	AC 240 V 6 A; DC 28 V 3 A DC 65 V 1 A; DC 80 V 0.5 A
Typical life	5,000 operations at $1 \times I_N$
Ambient temperature	-40...+85 °C (-40...+185 °F)
Insulation co-ordination (IEC 60664)	2.5 kV/2 reinforced insulation in operating area
Dielectric strength	test voltage
operating area	AC 3,000 V
pole to pole	AC 1,500 V
main to auxiliary circuit	AC 3,000 V
switching to trip circuit	AC 1,500 V
Insulation resistance	> 100 M Ω (DC 500 V)
Interrupting capacity (I_{cn})	0.1...125 A: 5,000 A (resistive load) 0.1...100 A: 3,000 A (inductive load) 125 A: 2,000 A (inductive load)
Degree of protection (IEC 60529)	operating area IP40 terminal area IP00
Vibration	
with toggle down:	10 g (57-2000 Hz) \pm 0.76mm (10-57Hz) at $0.9 I_N$
directions 1, 2, 3, 4, 5:	10 g at $1 \times I_N$
with curve F1:	10 g at $0.8 \times I_N$ in all planes. (57-2000 Hz) \pm 0.76 mm (10-57 Hz) to IEC 60068-2-6, test Fc 10 frequency cycles/axis
Shock	
directions 1, 2, 3, 4, 5:	100 g (11 ms) at $1 \times I_N$,
direction 6:	100 g (11 ms) at $0.8 \times I_N$,
with curve F1:	100 g (11 ms) at $0.8 \times I_N$ to IEC 60068-2-27, test Ea
Corrosion	96 hours at 5% salt mist, to IEC 60068-2-11, test Ka
Humidity	240 hours at 95 % RH, to IEC 60068-2-3, test Ca
Flammability	Class I1 to NF EN ISO 4589-3 and ISO 4589-1 and -2
Smoke emission visibility	Class F0 to NF X 10-702-2 »smoke chamber«
Mass	approx. 65 g per pole depending on version

Ordering information

Type No.
8345

Mounting

- B** flange mounting, with rectangular aperture with mounting nut 6-32UNC
- C** flange mounting, with rectangular aperture with mounting nut M3
- E** flange mounting, with round aperture with mounting nut 6-32UNC
- F** flange mounting, with round aperture with mounting nut M3

Configuration

- 0** without barrier
- 1** with small barrier
- 2** with large barrier

Number of poles

- 0** single pole unprotected
- 1** single pole protected
- 2** two pole protected

Actuator configuration

- A** all poles with standard toggle
- B** reduced number of standard toggles
- Z** without actuator

Terminal design

- L** screw terminals M5 ≤ 50 A
- M** solder terminals ≤ 75 A
- P** blade terminals ≤ 35 A
- R** round connectors 6 mm
- S** stud terminals M5 ≤ 60 A
- T** stud terminals 10-32UNF-3A ≤ 60 A
- U** stud terminals M6 ≤ 125 A
- V** stud terminals 1/4-20UNC-3A ≤ 125 A
- W** laminated round terminals ≤ 125 A

Terminal hardware

- 0** without
- 3** with washer and nut
- 6** Phillips screws

Characteristic curve

- F1** instantaneous trip ≤ 50 A (tripping current 150 %)
- F7** instantaneous trip ≤ 50 A (tripping current 125 %)
- K1** short delay
- M1** medium delay
- Q0** switch only
- T1** long delay

Version

- D** standard

Colour configuration

- B1** black actuator
- B2** white actuator
- B3** blue actuator

Marking

	front plate	actuator base
A1	without	without
A2	I_N	without
A3	I_N , characteristic curve	without
A4	I_N , characteristic curve, wiring diagram on side	without
B1	without	ON-OFF
B2	I_N	ON-OFF
B3	I_N , characteristic curve	ON-OFF
B4	I_N , characteristic curve, wiring diagram on side	ON-OFF

Rated voltage

- A** DC 110 V

Current ratings

- 0.05...125 A
- higher current ratings upon request

8345 - C 0 1 A - U 3 M1 - D B1 A1 A - 60 A ordering example

Ordering information for auxiliary contact module

Type number
X8345

Module

- S** auxiliary contact module

Auxiliary contacts

- 01** in all poles
- 02** in pole 1 only
- 04** in pole 2 only

Auxiliary contact version

- H** auxiliary contacts standard, gold-flushed
- K** auxiliary contacts, tin-plated (symmetrical terminals)

Auxiliary contact function

- W1** 1 changeover
- W2** 2 changeover

Terminal design

- 02** microswitch with blade terminals
DIN 46244-A2.8-0.5
- M** mounted to base unit

X8345 - S 01 H W1 02 M ordering example

Remote trip coil available to special order!

Dimensions

Mounting version B/C

Flange mounting rectangular aperture

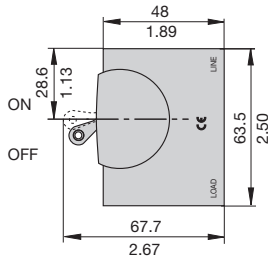

number of poles 1 to 2
pole 1 2

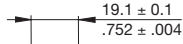

mounting thread M3 or 6-32
all dimensions referred to the top edge
mounting depth 4.2 mm/.165 in.
max. insertion depth 5.5 mm
max. tightening torque 0.33 Nm

Cut-out dimensions:

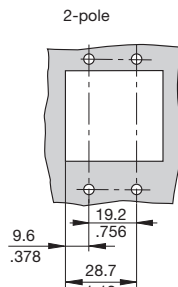
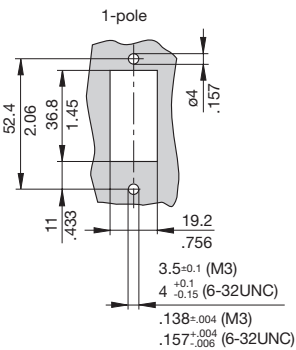

Mounting version E/F

Flange mounting round aperture

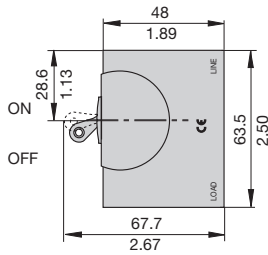

number of poles 1 to 2
pole 1 2

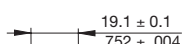

mounting thread M3 or 6-32
all dimensions referred to the top edge
mounting depth 4.2 mm/.165 in.
max. insertion depth 5.5 mm
max. tightening torque 0.33 Nm

Cut-out dimensions:

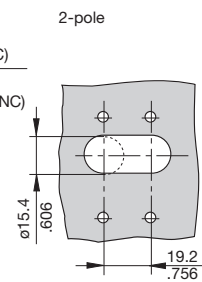
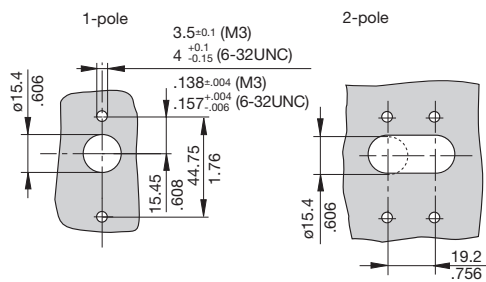

Installation drawing

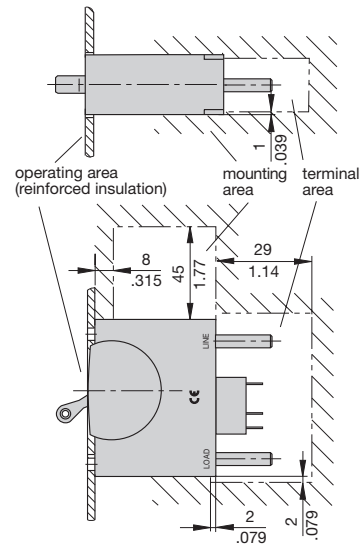

Actuator configuration

A 1 toggle per pole, mounting version B/C

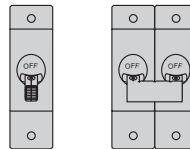

B reduced number of toggles per unit, mounting version B/C

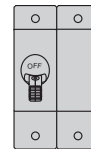

Z without toggles

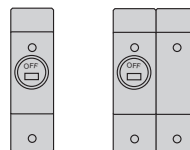

A 1 toggle per pole, mounting version E/F

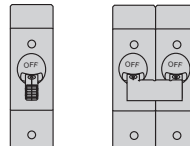

B reduced number of toggles per unit, mounting version E/F

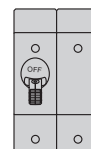

This is a metric design and millimeter dimensions take precedence (mm/inch)

Terminal design / Dimensions

P - with blade terminals

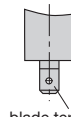
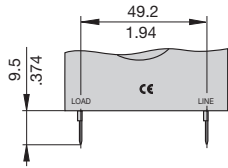

blade terminal A6.3-0.8 (QC .250) DIN 46244

L - with screw terminals

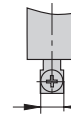
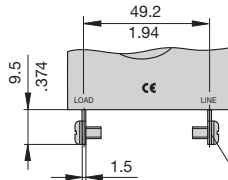

terminal with flat head screw M5 tightening torque max. 1.2 Nm

M - with solder terminals

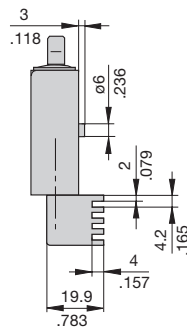
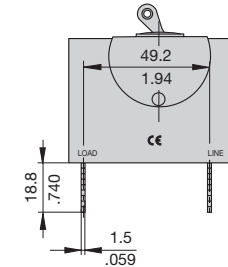

R - round connectors D = 6 mm (dia .236) (version H) asymmetrical terminals (not for UL 489)

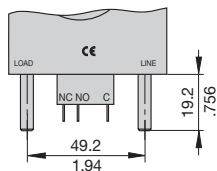

S/U/T/V - with auxiliary contacts (version H) asymmetrical terminals (not for UL 489)

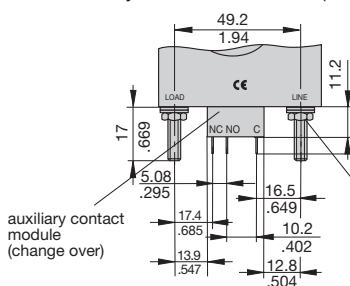

tightening torque:
10-32 UNF, M5 max. 2 Nm
1/4-20 UNC, M6 max. 3 Nm

auxiliary contacts version K symmetrical terminals

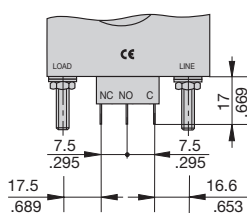

W - laminated round terminals

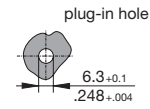
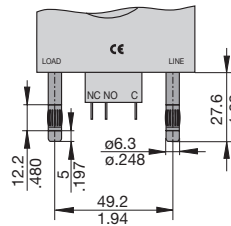

Internal connection diagrams

1-pole protected magnetically

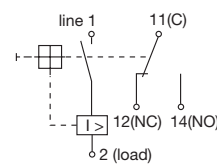

multipole

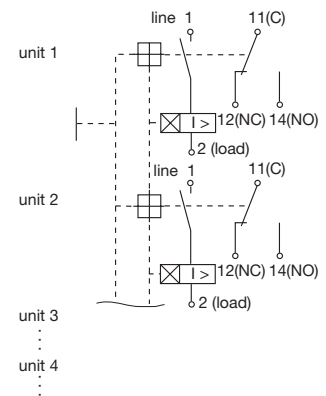

1-pole protected hydraulic-magnetically

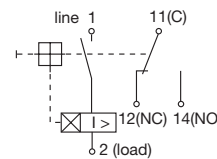

This is a metric design and millimeter dimensions take precedence ($\frac{\text{mm}}{\text{inch}}$)

Typical time/current characteristics at +23 °C / +73.4 °F

(trip time at rated current and all poles symmetrically loaded)

Curve F1 (instantaneous trip) ≤ 50 A

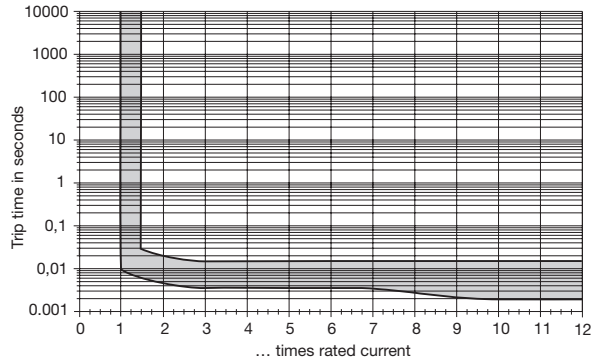

Curve F7 (instantaneous trip) ≤ 50 A

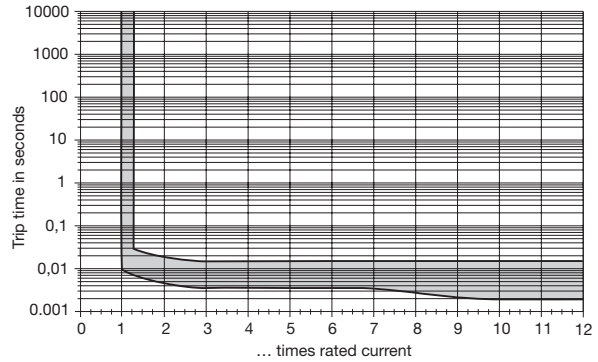

Curve K1 (short delay)

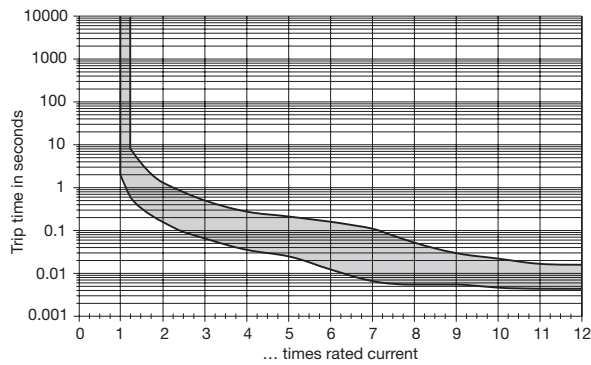

Curve M1 (medium delay)

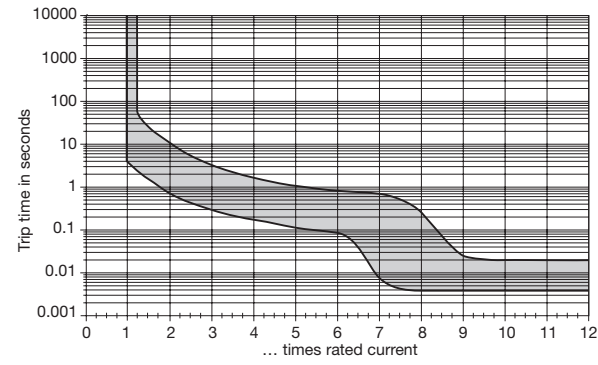

Curve T1 (long delay)

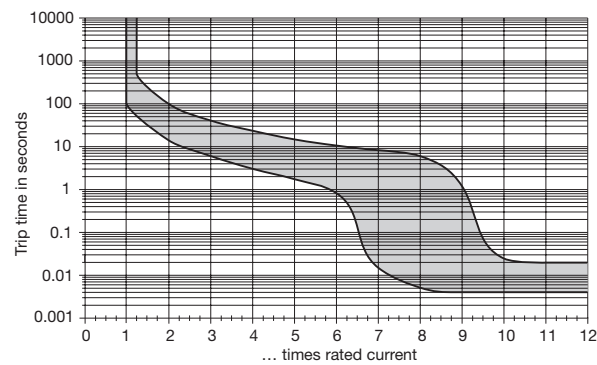

All curves will only be maintained if the escutcheon is mounted on a vertical surface.

Other characteristic curves to special order (e. g. pulse delayed, for high inrush currents or capacitive loads).

Interphase barriers / Dimensions

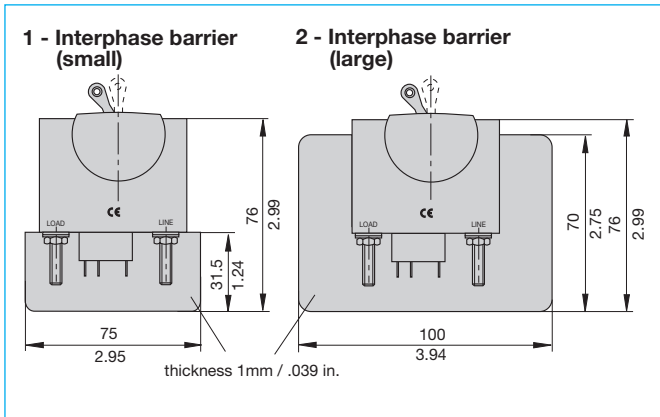

Shock directions

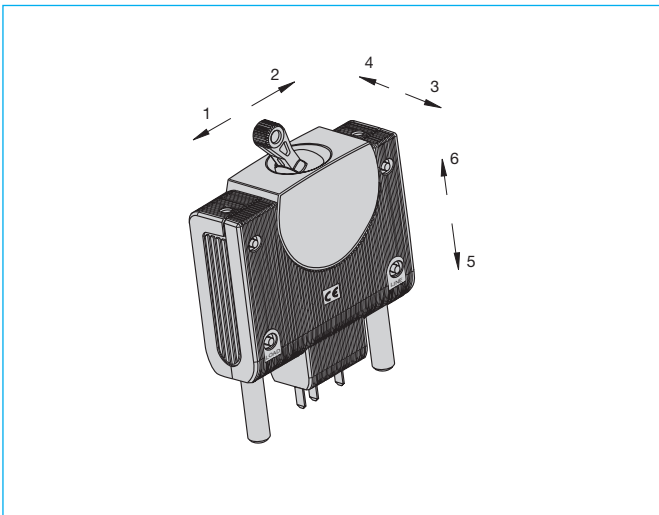

Accessories

Splash cover (IP65) for 1-, 2-pole (only for mounting version B/C)

	number of poles	mounting version	actuator configuration
X 222 444 01	1-pole	B	1
X 222 444 02	1-pole	C	1
X 222 444 11	2-pole	B	2
X 222 444 12	2-pole	C	2

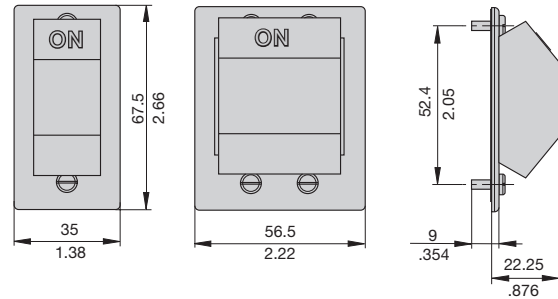

Toggle guard (only for mounting version B/C)
Y 307 381 01

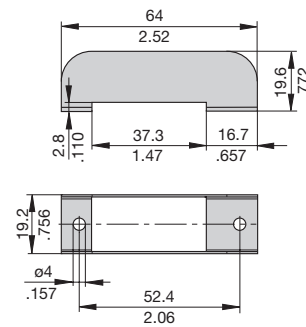

This is a metric design and millimeter dimensions take precedence ($\frac{\text{mm}}{\text{inch}}$)

All dimensions without tolerances are for reference only. In the interest of improved design, performance and cost effectiveness the right to make changes in these specifications without notice is reserved. Product markings may not be exactly as the ordering codes. Errors and omissions excepted.