

**M12 x 1 round connector  
female connector M12 x 1  
WWAK3-2/S398**

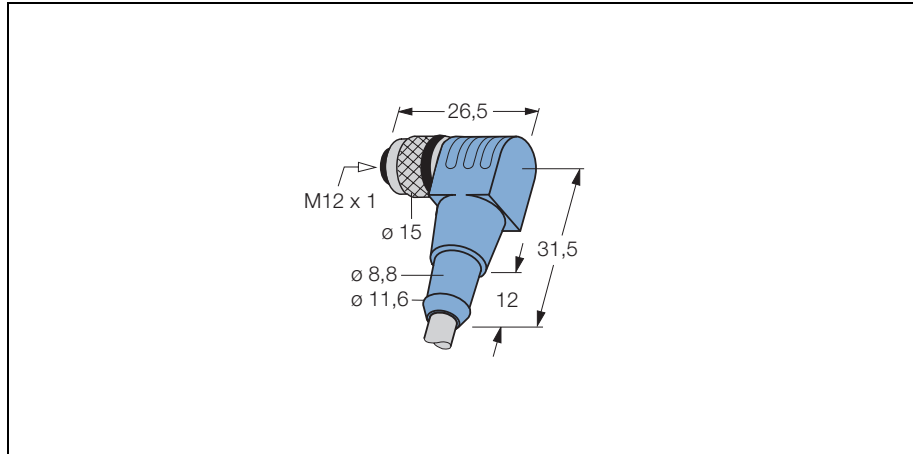

- **robust and pre-assembled round connector**
- **plastic moulding**
- **degree of protection IP67**
- **also available with other cable lengths and materials**
- **PUR cable for highest demands and high-flex applications**
- **irradiated**
- **PVC and halogen-free**
- **weld-splatter resistant**

**Wiring diagram**

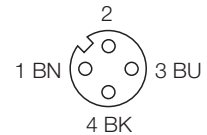

**cable quality S398**

Due to irradiation the PUR typical features of the PUR cable jacket are improved significantly. The mechanical stability and the abrasion resistance are increased; weld splatter resistance is also achieved. It is suited for use in the field of robot technology, particularly welding robots, tooling machinery, assembly and production lines and in machining applications. This bending and torsion resistant cable can be used at continuous temperatures of up to + 105°C.

<b>Type</b>	WWAK3-2/S398
Ident-No.	8014314
<b>connector</b>	female connector, M12 x 1, angled
Polarity	3-pole
Contact carriers	plastic, TPU, black also with B type coding on request
Contacts	metal, CuZn, gold-plated
Grip	plastic, TPU, blue
Seal	plastic, FPM/FKM
Coupling nut/screw	metal, CuZn, nickel-plated stainless steel coupling nut/screw available on request
Protection degree	IP67, only with screws tightened
Mechanical lifespan	min. 100 Contact durability
Pollution degree	3/2
<b>Cable</b>	S398, D12YSL11X-JB, irradiated
Cable diameter	Ø 4.4 mm
Cable length	2 m
Cable jacket	PUR, orange
Core insulation material	PE
Core insulation colours	BN, BU, BK
Core cross-section	3 x 0.34 mm <sup>2</sup>
Litz wire design	34 x 0.1 mm
Bending radius (moving state)	minimum 12 x Cable diameter
<b>Rated voltage</b>	max. 250 V
Insulation resistance	≥ 10 <sup>9</sup> Ω
Current carrying capacity	4 A
Forward resistance	≤ 5 mΩ
Ambient temperature connector	-30 ... + 90 °C
Cable ambient temperature	-50 ... + 105 °C