

**M12 x 1 round connector
female M12 x 1 connector with LED
WWAK3P2-10/S74**

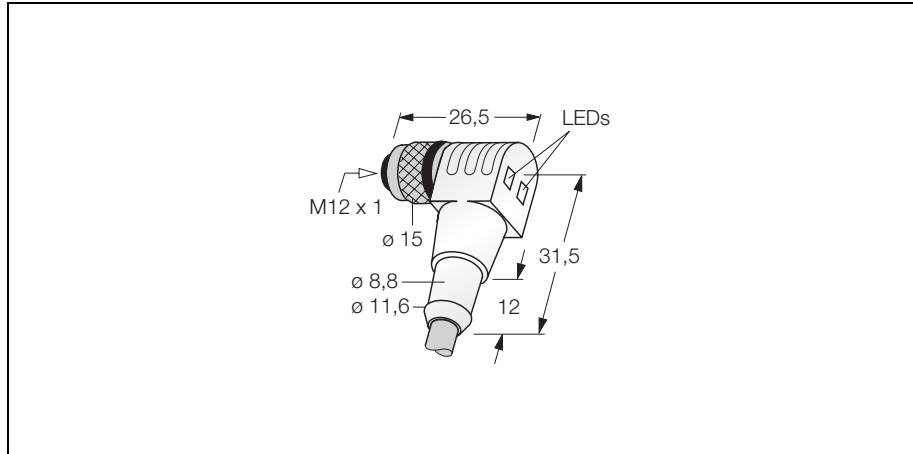

- **robust and pre-assembled round connector**
- **plastic moulding**
- **degree of protection IP67**
- **also available with other cable lengths and materials**
- **top-quality PUR cable for highest demands and high-flex applications**
- **PVC and halogen-free, trailing cable**
- **resistance to both bending and torsional stress**

Wiring diagram

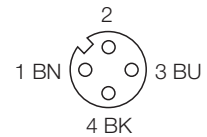

cable quality S74

Specially developed, high-flex control cable suited for use on industrial robots, rotation and tilting tables; it may also be used as a machine control cable for extreme environmental conditions. These cables are used in those applications where bending and torsional stress occur simultaneously and long-life characteristics are indispensable. The PUR cable jacket provides excellent resistance to oils, lubricants, cooling agents and other aggressive media. The cable resists continuous temperatures of up to +105 °C.

Type	WWAK3P2-10/S74
Ident-No.	8009245
connector	female connector, M12 x 1, angled
Polarity	3-pole
Contact carriers	plastic, TPU, black also with B type coding on request
Contacts	metal, CuZn, gold-plated
Grip	plastic, TPU, transparent
Seal	plastic, FPM/FKM
Coupling nut/screw	metal, CuZn, nickel-plated stainless steel coupling nut/screw available on request
Protection degree	IP67, only with screws tightened
Switch function	pnp
Operating voltage display	LED green
Switch state display	LED yellow
Mechanical lifespan	min. 100 Contact durability
Pollution degree	3/2
Cable	S74, D12YSL11Y-OB, halogen-free, highly flexible
Cable diameter	Ø 4.6 mm
Cable length	10 m
Cable jacket	PUR, orange
Core insulation material	TPE
Core insulation colours	BN, BU, BK
Core cross-section	3 x 0.34 mm ²
Litz wire design	43 x 0.1 mm
Bending radius (moving state)	minimum 10 x Cable diameter
Rated voltage	10 ... 30
Insulation resistance	≥ 10 ⁹ Ω
Current carrying capacity	4 A
Forward resistance	≤ 5 mΩ
Ambient temperature connector	-30 ... + 90 °C
Cable ambient temperature	-50 ... + 105 °C

