

**M12 x 1 round connector
female connector M12 x 1
WWAK3-10/S90**

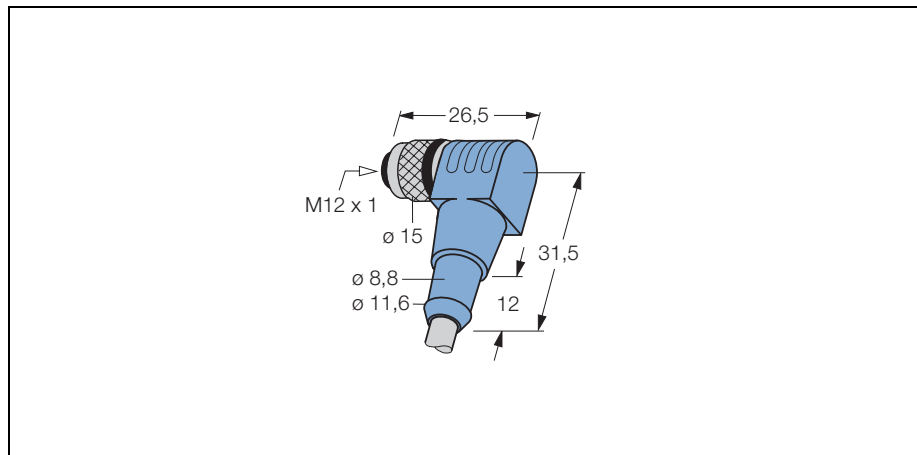

- **robust and pre-assembled round connector**
- **plastic moulding**
- **degree of protection IP67**
- **also available with other cable lengths and materials**
- **PUR cable**
- **with trailing capability**

Wiring diagram

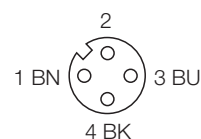

Type	WWAK3-10/S90
Ident-No.	8007144
connector	female connector, M12 x 1, angled
Polarity	3-pole
Contact carriers	plastic, TPU, black also with B type coding on request
Contacts	metal, CuZn, gold-plated
Grip	plastic, TPU, blue
Seal	plastic, FPM/FKM
Coupling nut/screw	metal, CuZn, nickel-plated stainless steel coupling nut/screw available on request
Protection degree	IP67, only with screws tightened
Mechanical lifespan	min. 100 Contact durability
Pollution degree	3/2
Cable	S90, LifYY11Y
Cable diameter	Ø 5.2 mm
Cable length	10 m
Cable jacket	PUR/PVC, grey
Core insulation material	PVC
Core insulation colours	BN, BU, BK
Core cross-section	3 x 0.34 mm ²
Litz wire design	43 x 0.1 mm
Bending radius (moving state)	minimum 10 x Cable diameter
Rated voltage	max. 250 V
Insulation resistance	≥ 10 ⁹ Ω
Current carrying capacity	4 A
Forward resistance	≤ 5 mΩ
Ambient temperature connector	-30 ... + 90 °C
Cable ambient temperature	-40 ... + 80 °C

cable quality S90

The robust PUR/PVC cable with PUR cable jacket and PVC conductor insulation is suited for use in tooling machinery, assembly and production lines, machining and robot applications. This widely used cable provides good oil and chemical resistance and is highly abrasion resistant. It is also suited for trailing applications.