

**M12 x 1 round connector
female connector M12 x 1
WWAK3-5/P00**

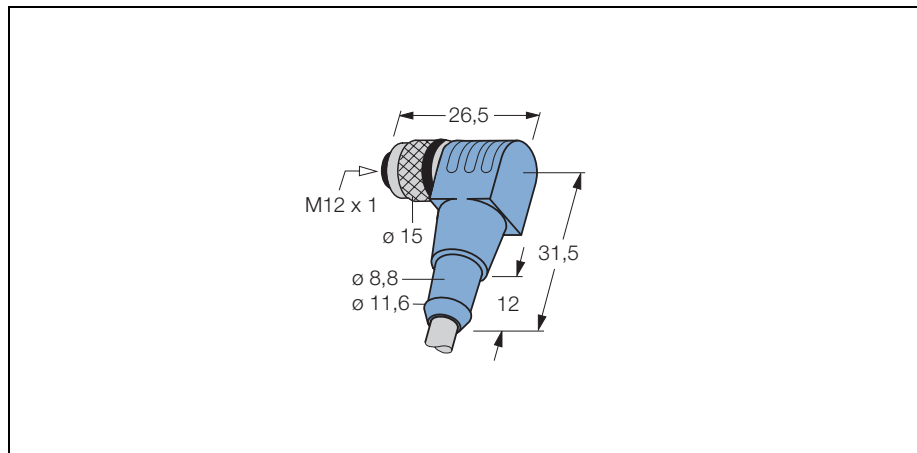

- **robust and pre-assembled round connector**
- **plastic moulding**
- **degree of protection IP67**
- **also available with other cable lengths and materials**
- **PVC cable**
- **suited to average mechanical stress**

Wiring diagram

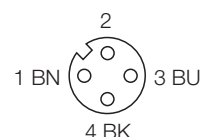

cable quality P00

Pure PVC cable, resistant to average mechanical strain, for use in packaging machinery as well as assembly and production lines. Good resistance against acids and alkalis and thus suited for use in the food and beverage industry. Limited resistance to abrasion, conditional resistance to oils and chemicals.

Type	WWAK3-5/P00
Ident-No.	8007138
connector	female connector, M12 x 1, angled
Polarity	3-pole
Contact carriers	plastic, TPU, black also with B type coding on request
Contacts	metal, CuZn, gold-plated
Grip	plastic, TPU, blue
Seal	plastic, FPM/FKM
Coupling nut/screw	metal, CuZn, nickel-plated stainless steel coupling nut/screw available on request
Protection degree	IP67, only with screws tightened
Mechanical lifespan	min. 100 Contact durability
Pollution degree	3/2
Cable	P00, LiYY
Cable diameter	Ø 5.2 mm
Cable length	5 m
Cable jacket	PVC, grey
Core insulation material	PVC
Core insulation colours	BN, BU, BK
Core cross-section	3 x 0.34 mm ²
Litz wire design	43 x 0.1 mm
Bending radius (moving state)	minimum 10 x Cable diameter
Rated voltage	max. 250 V
Insulation resistance	≥ 10 ⁹ Ω
Current carrying capacity	4 A
Forward resistance	≤ 5 mΩ
Ambient temperature connector	-30 ... + 90 °C
Cable ambient temperature	-40 ... + 80 °C