

**M12 x 1 round connector
female connector, field-wireable
WAKC5**

- robust, field-wireable round connector
- degree of protection IP67
- screw/terminal connection

Wiring diagram

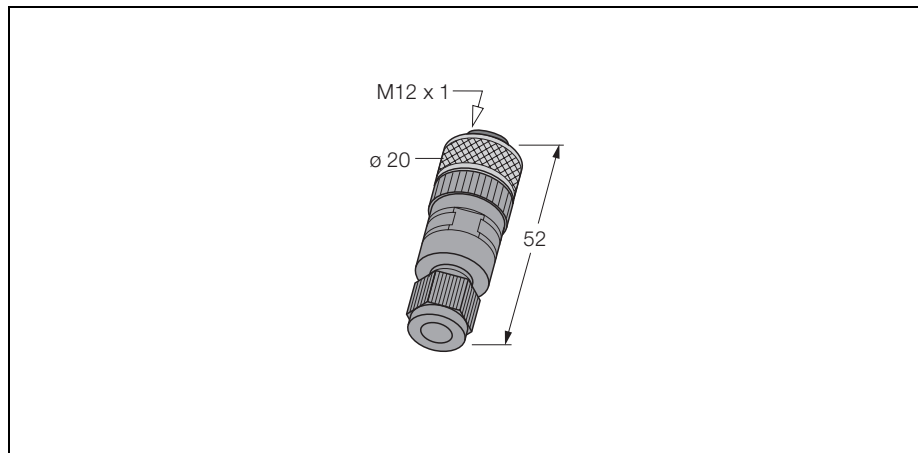
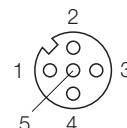

Type	WAKC5
Ident-No.	8004815
connector	field-wireable female connector, M12 x 1, straight
Polarity	5-pole
Contact carriers	plastic, PA, black
Contacts	metal, CuZn, CuSnZn
Grip	plastic, PA, black
Seal	plastic, FKM/FPM
Coupling nut/screw	metal, CuZn, nickel-plated
Screw-in thread seal	plastic, FKM
Protection degree	IP67, only with screws tightened
External diameter of the cable	3 ... 6.5 mm
Core cross-section/clamping ability	max. 0.75 mm ²
Screw-in thread	PG 7
Connection mode	screw terminals
Pollution degree	3
Rated voltage	max. 30 V
Insulation resistance	≥ 10 ⁹ Ω
Current carrying capacity	4 A
Forward resistance	≤ 5 mΩ
Ambient temperature connector	-25 ... + 90 °C