

**Bi10U-G30-ADZ30X2-B1131**

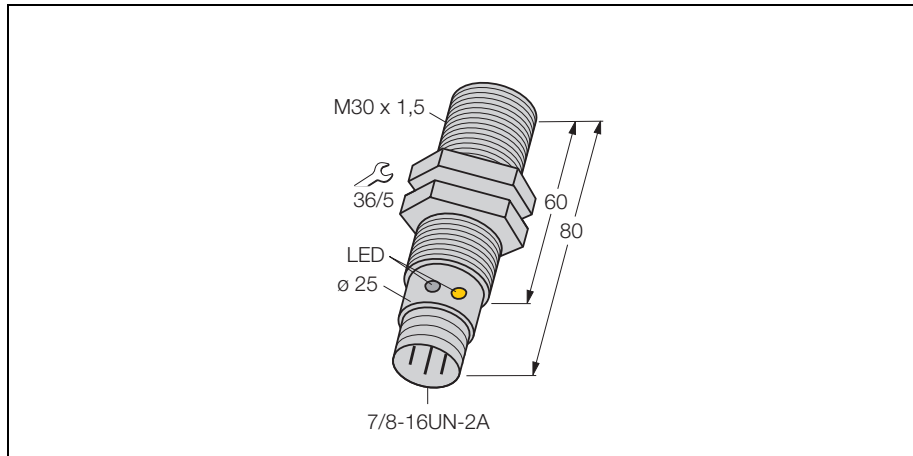

- threaded barrel, M30 x 1,5
- chrome-plated brass
- factor 1 for all metals
- magnetic field immune
- extended temperature range
- high switching frequency
- 2-wire AC, 20...250 VAC
- 2-wire DC, 10...0.300 VDC
- normally open
- connector, 7/8"

**Wiring diagram**

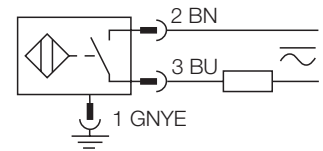

**Function principle**

Inductive sensors are designed for wear-free and non-contact detection of metal objects. Due to a ferrite-less 3-coil system, uprox factor 1 sensors have distinct advantages. They detect all metals at the same switching distance, are magnetic field immune and feature large switching distances.

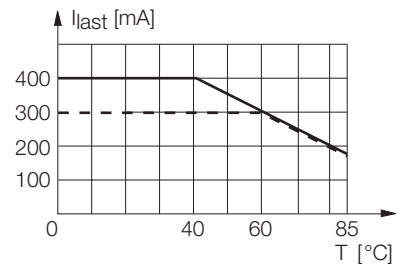

<b>Type</b>	Bi10U-G30-ADZ30X2-B1131
Ident-No.	4281612
<b>Rated operating distance Sn</b>	10 mm
Mounting condition	flush
Assured switching distance	≤ (0,81 x Sn) mm
Repetition accuracy	≤ 2 %
Temperature drift	≤ ± 10 %
Hysteresis	≤ ± 15 %, ≤ -25 °C v ≥ +70 °C
ambient temperature	-30 ... + 85 °C
<b>Operating voltage</b>	20... 250 VAC
Operating voltage	10... 300 V DC
AC rated operational current	≤ 400 mA
DC rated operational current	≤ 300 mA
Mains frequency	50 ... 60 Hz
Residual current	≤ 1.7 mA
Rated insulation voltage	≤ 1.5 kV
Surge current	≤ 3 A (≤ 20 ms max. 5 Hz)
Short-circuit protection	yes / latching
Voltage dip at I <sub>e</sub>	≤ 6 V
Wire breakage / reverse polarity protection	yes / complete
Output function	2-wire, normally open
Smallest operating current I <sub>m</sub>	≥ 3 mA
Insulation class	□
Switching frequency	≤ 0.02 kHz
<b>Housing style</b>	threaded barrel; M30 x 1,5
Dimensions	80 mm
Housing material	metal, CuZn, chrome-plated
Material active area	plastic, PBT
Housing nut tightening torque	75 Nm
Connection	connector, 7/8"
Vibration resistance	55 Hz (1 mm)
Shock resistance	30g (11 ms)
Protection degree	IP67
<b>Operating voltage display</b>	LED green
Switch state display	LED yellow

Mounting instructions	minimum distances
Distance D	2 x B
Distance W	3 x Sn
Distance T	3 x B
Distance S	1,5 x B
Distance G	6 x Sn

---

<b>Diameter of the active area B</b>	Ø 30 mm
--------------------------------------	---------

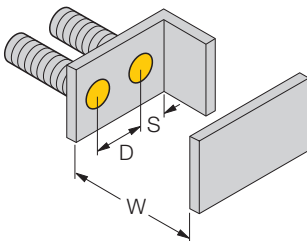
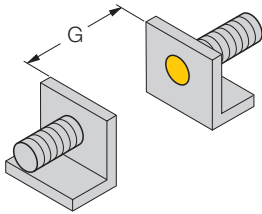
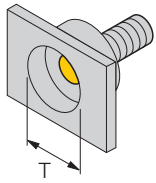

**Accessories**

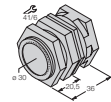
Type code	Ident-No.	Short text	Dimension drawing
QM-30	6945103	quick-mount fixing clamp with dead-stop; material: chrome-plated brass male thread M36 x 1.5. Note: The switching distance of proximity switches can be reduced by the use of quick mounting brackets.	
BST-30B	6947216	fixing clamp with dead-stop; material: PA6	