

Description

Single, double and three pole high performance thermal-magnetic circuit breakers with tease-free, trip-free, snap action mechanism and toggle actuation (S-type TM CBE to EN 60 934; also to EN 60 947). Designed for rail, panel or surface mounting. Available with a choice of characteristic curves and optional auxiliary contacts.

Typical applications

Motors, generators, transformers, thyristors and silicon rectifiers.

Interrupting capacity to IEC 60947/EN 60947

AC voltage					
Number of poles	Voltage rating	Interrupting capacity I_N 12...125A	Power factor	Interrupting capacity I_N 7 + 10 A	Power factor
1	AC 240 V	5,000 A	$\cos\varphi = 0.7$	3,500 A	$\cos\varphi = 0.8$
2	AC 240 V	8,000 A	$\cos\varphi = 0.7$	6,000 A	$\cos\varphi = 0.7$
3	3 AC 415 V	5,000 A	$\cos\varphi = 0.7$	3,000 A	$\cos\varphi = 0.85$
3	3 AC 500 V	4,000 A	$\cos\varphi = 0.8$	2,500 A	$\cos\varphi = 0.85$
3	3 AC 660 V	2,000 A	$\cos\varphi = 0.85$	2,000 A	$\cos\varphi = 0.85$

DC voltage					
Number of poles	Voltage rating	Interrupting capacity $I_N = 12...125$ A	$I_N = 7+10$ A	Time constant	
1	DC 110 V	3,000 A	3,000 A	L/R = 13 ms	
1	DC 110 V	5,000 A	3,500 A	L/R = 5 ms	
2	DC 110 V	5,000 A	3,000 A	L/R = 13 ms	
2	DC 110 V	10,000 A	6,000 A	L/R \approx 0 ms	
2	DC 220 V	2,000 A	2,000 A	L/R = 13 ms	
2	DC 220 V	3,000 A	3,000 A	L/R \approx 0 ms	

Standard current ratings and typical internal resistance values

Curves 01, 02, 04, 05:		Curves B3, C3:	
Current rating (A)	Internal resistance (Ω) per pole	Current rating (A)	Internal resistance (Ω) per pole
10	0.033	7	0.033
16	0.015	10	0.015
20	0.010	12	0.015
25	0.0062	16	0.010
32	0.0039	20	0.0062
40	0.0031	25	0.0039
50	0.0022	32	0.0031
63	≤ 0.002	40	0.0022
80	≤ 0.002	50	≤ 0.002
90	≤ 0.002	63	≤ 0.002
100	≤ 0.002	80	≤ 0.002
125	≤ 0.002	100	≤ 0.002

Approvals

Authority	Voltage ratings	Current ratings
UL	AC 277 V	7...125 A (type 520)
UL Canada	AC 277 V	7...125 A (type 520)

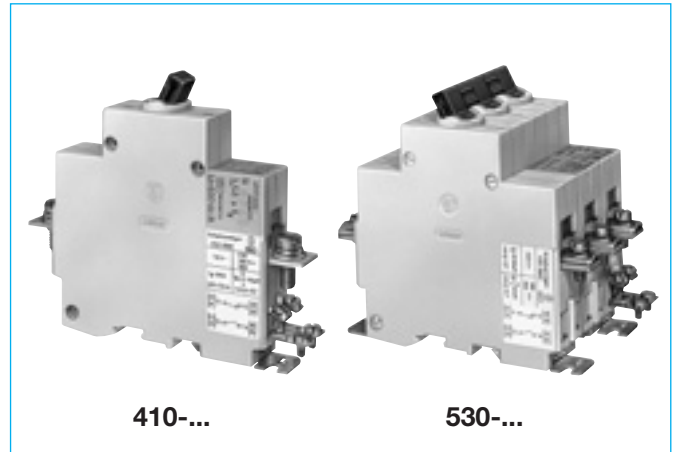

Technical data

Voltage rating	AC 240 V; 3 AC 415 V; 3 AC 500 V; 3 AC 660 V (50/60 Hz); DC 110 V; DC 220 V series connection	
Current rating range	10...125 A (EN 60947), curves 01/02/04/05 7...100 A (EN 60898), curves B3/C3/01	
Auxiliary circuit	6 A, AC 240 V or DC 28 V 1 A, DC 110 V	
Typical life	10,000 operations at $1 \times I_N$ 20,000 operations mechanical	
Ambient temperature	-20...+60 °C (-4...+140 °F)	
Insulation co-ordination (IEC 60664 and 60664A)	rated impulse withstand voltage 6 kV	pollution degree 3
Dielectric strength (IEC 60664 and 60664A)	test voltage operating area pole/pole main circuit/aux.circuit aux. circuit 11-12/13-14	AC 3,300 V AC 3,300 V AC 2,200 V AC 1,000 V
Insulation resistance	> 100 M Ω (DC 500 V)	
Degree of protection (IEC 60529/DIN 40050)	operating area IP40 terminal area IP00	
Vibration	curves 02/04/05/B3/C3: 4 g (60-500 Hz) ± 0.30 mm (10-60 Hz) curve 01: 3 g (60-500 Hz) ± 0.23 mm (10-60 Hz) to IEC 60068-2-6, test Fc 10 frequency cycles/axis	
Shock	curves 02/04/05/B3/C3: 50 g (11 ms) directions 1, 2, 3, 4, 5 30 g in direction 6 curve 01: 30 g (11 ms) in directions 1, 2, 3, 4, 5 20 g in direction 6 to IEC 60068-2-7, test Ea	
Corrosion	96 hours at 5 % salt mist, to IEC 60068-2-11, test Ka	
Humidity	240 hours at 95 % RH to IEC 60068-2-3, test Ca	
Mass	410 (1-pole): approx. 290 g 520 (2-pole): approx. 580 g 530 (3-pole): approx. 870 g	

Ordering information

Type No.

- 410** single pole (ratings > 125 A: suffix 17015 - parallel connection)
- 520** double pole
- 530** three pole

Terminal design - main terminals

K screw terminals

- 10-32 A pressure plate B5-DIN 46288 (curves B3/C3, 7-25 A)
- 40-63 A pressure plate B6-DIN 46288 (curves B3/C3, 32-63 A)
- 80-125 A terminal screw DIN 46206, sheet 2, form 1, M6 thread

Mounting

- 1** surface mounting
- 2** rail mounting (DIN EN 50022-35x7.5) or panel mounting
- 3** rail mounting on G profile (DIN EN 50035-G32) or panel mounting
- 4** panel mounting with cylinder head screw M3.5
- 5** mounting brackets

Magnetic trip curves

- 01** 2.1-3 x I_N AC (thyristor and rectifier protection)
- 02** 7-10 x I_N AC (motor and generator protection to EN 60947)
- 04** 3.5-5 x I_N AC (cable protection to EN 60947)
- 05** 4-6 x I_N AC (generator protection to EN 60947)
- B3** 3-5 x I_N AC (cable protection to EN 60898)
- C3** 5-10 x I_N AC (cable protection to EN 60898)

Auxiliary contacts optional (terminals M3.5)

- Si** one each N/O and N/C contact
- Si1** one N/C (11,12)
- Si2** one N/O (13,14)
- 2Si** two each N/O and N/C (types 520/530)
- 3Si** three N/C, three N/O (type 530)

Current ratings

7...125 A

520 - K - 1 - 01 - ... - 10 A ordering example

The exact number required can be built up from the table of choices shown above. Ordering references for optional features should be omitted if not required.

Mounting methods

Surface mounting -1

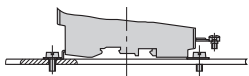

rail mounting (DIN EN 50 022-35x7,5) -2

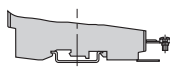

rail mounting on G profile (DIN EN 50 035-G32) -3

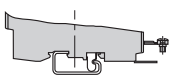

panel mounting -4

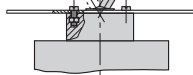

surface mounting with mounting brackets -5

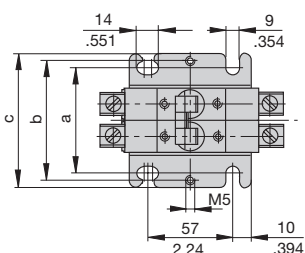

	a		b		c	
	mm	in.	mm	in.	mm	in.
type 410	50	1.97	61.5	2.42	70	2.76
type 520	72	2.84	83.5	3.29	92	3.62
type 530	94	3.70	105.5	4.15	114	4.49

Dimensions

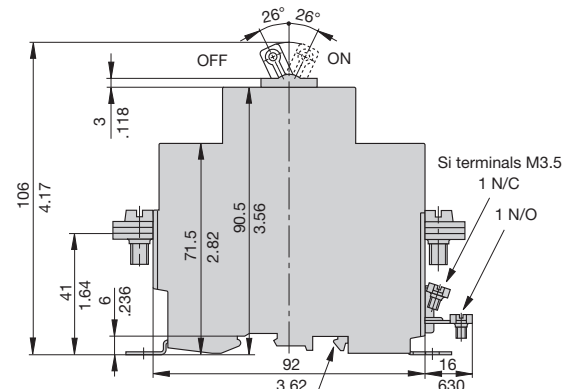

symmetrical rail DIN EN 50022-35x7.5
G profile rail DIN EN 50035-G32 (not shown)

M3.5 - thread max. 9 mm (.354 in.) deep
tightening torque max. 0.8 Nm

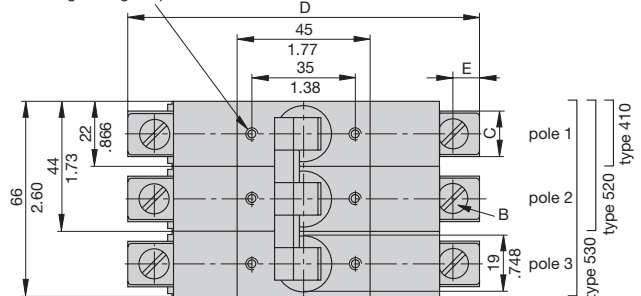

Current rating	Dimensions mm/in.				Terminal	Cross section (see DIN 46288)		Max. tightening torque
	B	C	D	E		with 1 or 2 equal conductors	with 2 different conductors	
≤ 32 A	M5	13 .512	114 4.49	7 .276	pressure plate B5 DIN 46288	2.5 mm ² to 10 mm ²	2.5 mm ² to 10 mm ²	2.0 Nm
≤ 63 A	M6	15.4 .606	120 4.72	9 .354	pressure plate B6 DIN 46288	4 mm ² to 16 mm ²	4 mm ² and 6 mm ² or 6 mm ² to 16 mm ²	2.5 Nm
≤ 125 A	M6	15.4 .606	120 4.72	9 .354	terminal screw			2.5 Nm

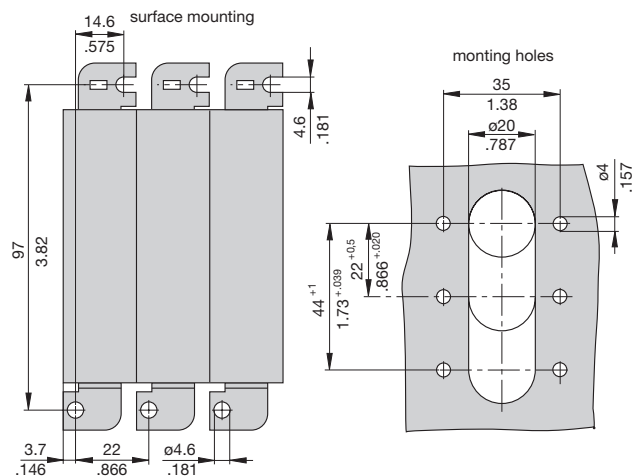

This is a metric design and millimeter dimensions take precedence (mm/ inch)

Typical time/current characteristics at +23°C/+73.4°F

Magnetic trip curves 01,02,04,05

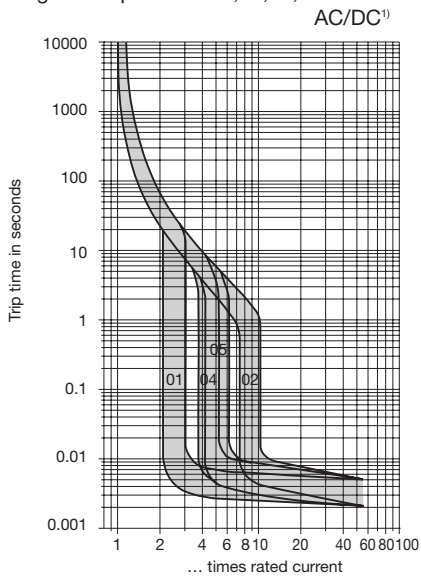

Magnetic trip curves B3,C3

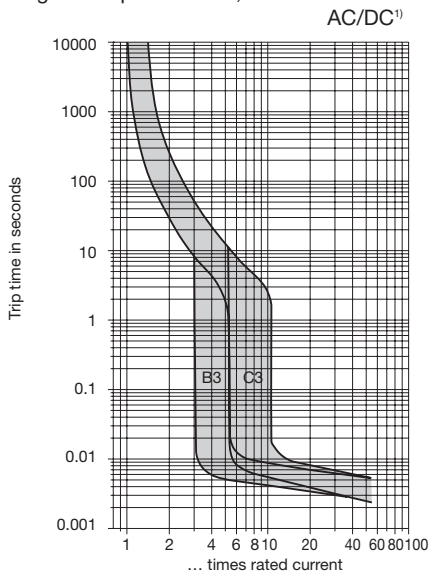

¹) Magnetic tripping currents are increased by 20% on DC supplies.

Internal connection diagrams

Type 410-K

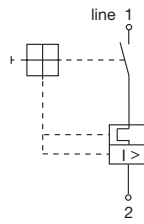

Type 410-K-Si

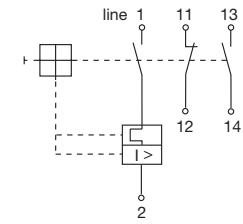

Type 520-K-Si

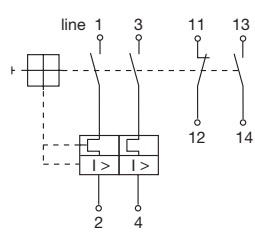

Type 520-K-2Si

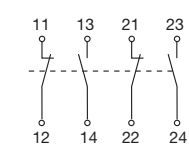

Type 530-K-Si

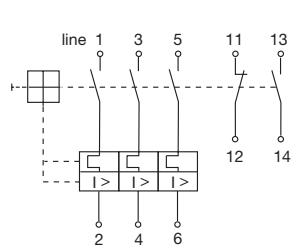

Type 530-K-3Si

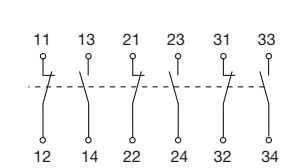

Shock directions

