

Description

Single pole thermal circuit breakers with push-to-reset, tease-free, trip-free, snap action mechanism (R type TO CBE to EN 60934; M-type when fitted with manual release features/type 2-6200 only). Featuring auxiliary contacts (1 x N/C; 1 x N/O) as standard. Options include manual release (type 2-6200 only), an additional unprotected circuit tap (-A3) and a centre reset position in which all contacts are open (-ZR: type 2-6200-H only). Approved to CBE standard EN 60934 (IEC 60934).

Typical applications

Motors, transformers, solenoids, controls for oil and gas boilers.

Ordering information

Type No.	
2-6200	flange mounting, with auxiliary contacts
2-6400	threadneck panel mounting, with auxiliary contacts mounting hardware bulk shipped
Mounting (type 2-6400 only)	
iG1	moulded threadneck 3/8-27UNS-2A
iG2	moulded threadneck M12 x 1
Terminal design - main circuit	
L10	solder terminals
P10	blade terminals A6.3-0.8 mm (QC .250)
Shunt terminal (optional)	
A3	shunt terminal same as main terminal (up to 7/5 A max. load; up to 16 A/10 A max. load)
Manual release (optional)	
H	manual release facility (type 2-6200 only)
Intermediate position (optional)	
ZR	intermediate position (type 2-6200-H only)
Auxiliary contacts (standard)	
Si	N/O and N/C contacts, solder terminals
Current ratings	
0.05...16 A	
2-6200 - .. - P10 - .. - .. - .. - Si - 8 A	ordering example

The exact part number required can be built up from the table of choices shown above. Ordering references for optional features should be omitted if not required.

Standard current ratings and typical internal resistance values

Current rating (A)	Internal resistance (Ω)	Current rating (A)	Internal resistance (Ω)
0.05	257	2	0.30
0.08	138	2.5	0.20
0.1	90	3	0.12
0.2	32.2	3.5	0.10
0.3	14.6	4	0.07
0.4	8.4	4.5	0.056
0.5	5.15	5	0.046
0.6	3.82	6	0.035
0.7	2.80	7	0.03
0.8	2.15	8	< 0.02
1	1.42	10	< 0.02
1.2	0.96	12	< 0.02
1.5	0.51	15	< 0.02
1.8	0.40	16	< 0.02

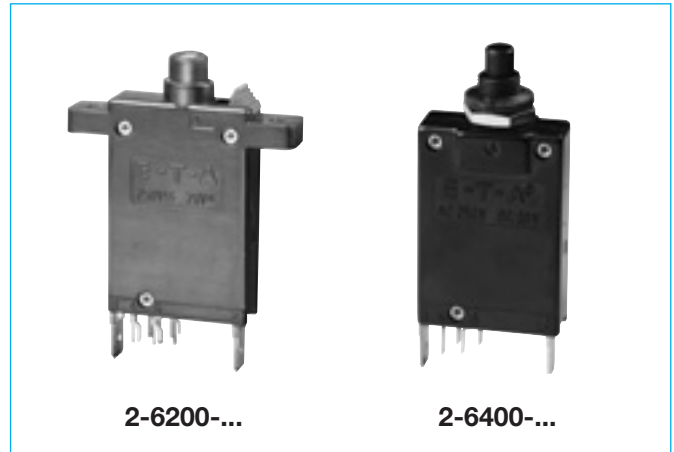

Technical data

For further details please see chapter: Technical Information

Voltage rating	AC 250 V; DC 28 V		
Current rating range	0.05...16 A		
Auxiliary circuit	1 A, AC 250 V/DC 28 V		
Typical life	AC 250 V / DC 28 V: 0.05...16 A 5,000 operations at 2 x I _N , inductive		
Ambient temperature	-20...+60 °C (-4...+140 °F)		
Insulation co-ordination (IEC 60664 and 60664A)	rated impulse withstand voltage	pollution degree	
	2.5 kV	2	
	reinforced insulation in operating area		
Dielectric strength (IEC 60664 and 60664A)	test voltage		
	operating area	AC 3,000 V	
	main circuit		
	to aux. circuit	AC 1,500 V	
	aux. circuit 4-5 to 6-7	AC 840 V	
Insulation resistance	> 100 MΩ (DC 500 V)		
Interrupting capacity I _{cn}	10 x I _N		
Interrupting capacity (UL 1077)	I _N	U _N	
	0.05...4.5 A	AC 250 V	200 A
	5...7 A	AC 250 V	1,000 A
	8...15 A	AC 250 V	2,000 A
	16 A	AC 250 V	3,500 A
Degree of protection (IEC 60529/DIN 40050)	operating area IP40 terminal area IP00		
Vibration	10 g (57-500 Hz) ±0.76 mm (10-57 Hz), to IEC 60068-2-6, test Fc, 10 frequency cycles/axis		
Shock	40 g (11 ms) to IEC 60068-2-27, test Ea		
Corrosion	96 hours at 5 % salt mist, to IEC 60068-2-11, test Ka		
Humidity	240 hours at 95 % RH to IEC 60068-2-3, test Ca		
Mass	approx. 25 g		

Approvals

Authority	Voltage ratings	Current ratings
VDE (EN 60934)	AC 250 V; DC 28 V	0.05...16 A
CSA/ UL	AC 250 V; DC 28 V	0.05...16 A

Installation drawings

2-6200-...

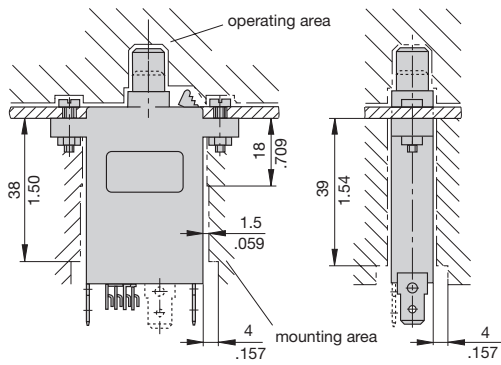

2-6400-...

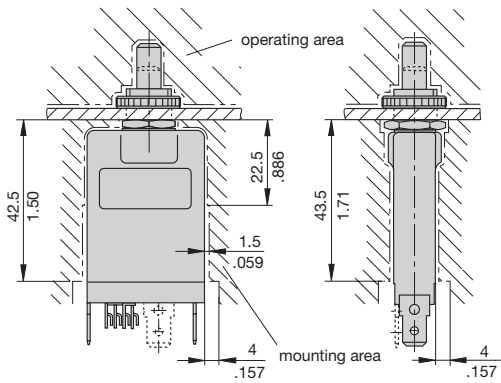

Terminal design

-P10 0.05...7 A

See dimension diagram.

-P10 8...16 A

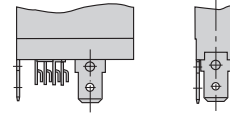

-P10-A3 0.05...16 A

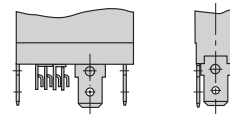

-L10 0.05...7 A

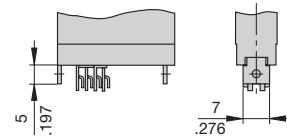

-L10 8...16 A

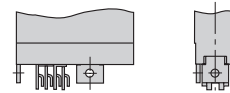

-L10-A3 0.05...16 A

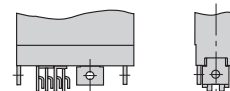

This is a metric design and millimeter dimensions take precedence ($\frac{\text{mm}}{\text{inch}}$)

Accessories for type 2-6400-...

With 3/8" threadneck (-iG1)

Water splash cover, transparent Y 300 538 01 and knurled nut Y 300 628 01 X 200 799 01 (IP64)

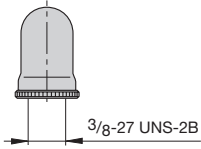

Water splash cover, transparent with special knurled nut X 200 798 02 (IP64)

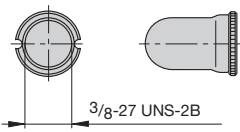

Hex nut with splash cover black without O ring X 210 739 01 (IP64)
transparent splash cover X 201 296 03 (IP64)

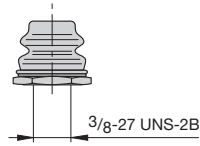

Separate hardware
Hex nut
Y 300 192 01

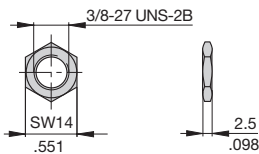

Knurled nut
Y 307 117 02

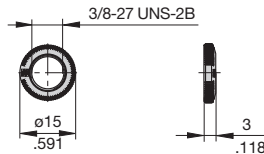

With M12 threadneck (-iG2)

Hex nut with splash cover, black X 201 296 01 without O ring (IP64)
X 200 801 03 with O ring (IP66)
Hex nut with splash cover, transparent X 200 801 08 with O ring (IP66)



Water splash cover, transparent with knurled nut and O ring X 210 663 01 (IP64)

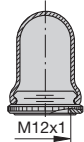

Hex nut
Y 300 116 02

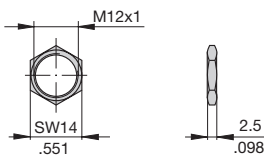

Knurled nut
Y 302 065 01

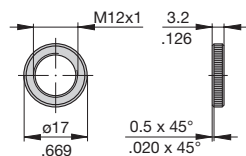

This is a metric design and millimeter dimensions take precedence ($\frac{\text{mm}}{\text{inch}}$)

All dimensions without tolerances are for reference only. In the interest of improved design, performance and cost effectiveness the right to make changes in these specifications without notice is reserved. Product markings may not be exactly as the ordering codes. Errors and omissions excepted.