

5

4

3

2

1

D

C

B

A

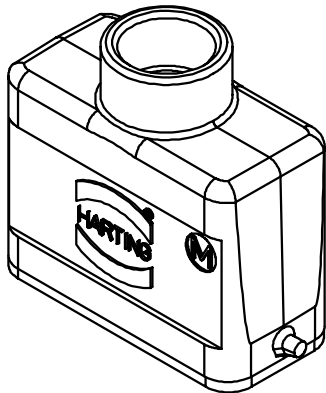
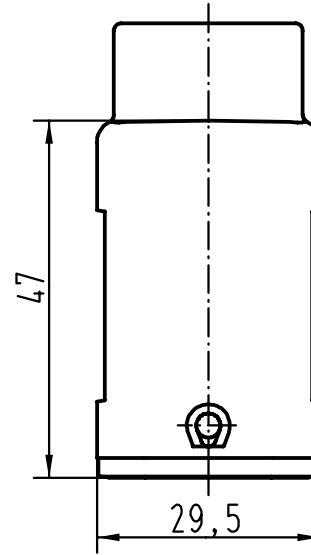
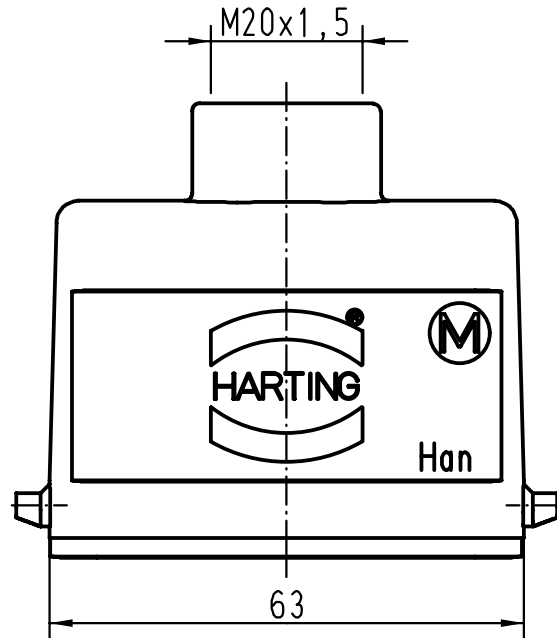

All Dimensions in mm Original Size DIN A 4		Techn. Character.			Nicht tolerierte Masse/ Free size tolerances	
			Dat.	Name	Massstab/ Scale <b>1:1</b>	<b>Han 10A-gg-M20</b> Tüllengehäuse/ hoods
			Detail.	16.11.00 ROH.		
			Insp.	KR		
			Stand.			
28834			HARTING KGaA			<b>TB 19 20 010 1440</b> Sub.
Mod.	Dat.	Name	D-32339 ESPELKAMP			
						Blatt/ page