

5

4

3

2

1

D

C

B

A

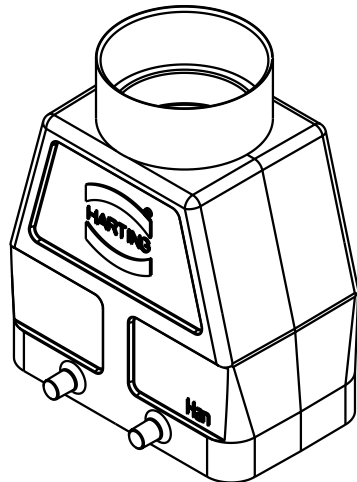
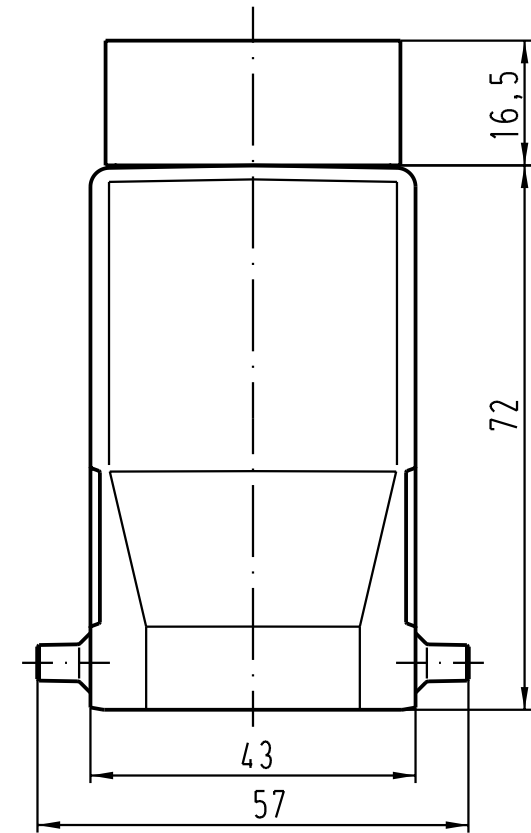
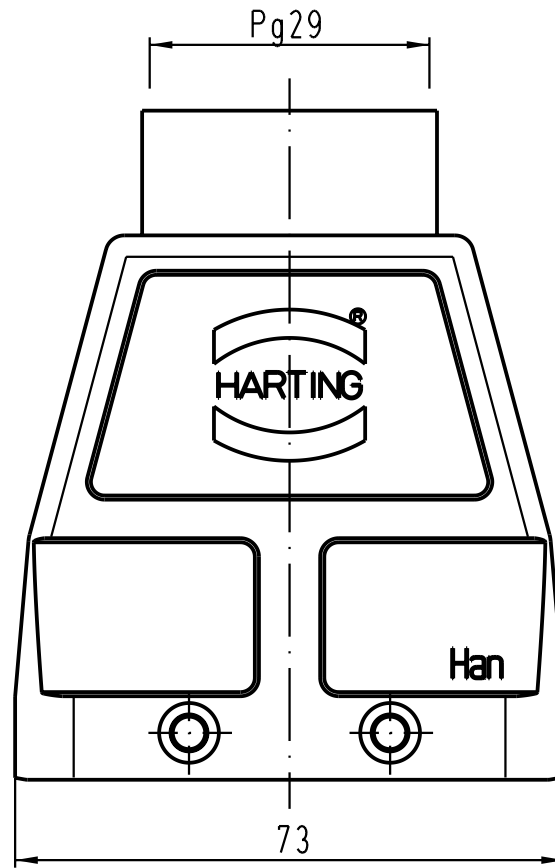

All Dimensions in mm Original Size DIN A 4		Techn. Character.			Nicht tolerierte Masse/ Free size tolerances	
			Dat.	Name	Massstab/Scale 1:1	Han 10B-gg-29 Tüllengehäuse/ hoods
		Detail.	22.10.01	Gö		
		Insp.		KR		
		Stand.				
30140		HARTING Electric GmbH & Co. KG D-32339 Espelkamp				TB 09 30 010 0423 Sub. TB 09 30 0.. 042. v. 03.02.93
Mod.	Dat.	Name				